

MPGs Sensor – for the detection of CNG, LPG

가스누설 경보용으로 사용되는 LPG/NG sensor는 접촉 연소식 및 산화물 반도체식이 주로 사용되며 형상에 따라 Bead/Thick film type로 구분하며, 서로의 장단점이 있다.

구분	장점	단점
접촉 연소식 (bead type)	선택성 우수 (잡 가스에 의한 오 동작이 작음)	수명이 짧음(약 2년) 센서의 감도가 작음
산화물 반도체식 (Thick film type)	수명이 오래감(약 4년 이상) 센서의 감도가 큼	선택성 나쁨 (잡 가스에 의한 오 동작이 큼)

GSLS61 센서는 가스누설경보기용으로 개발된 센서이며, 기존 산화물 반도체 센서의 단점인 **선택성을 대폭 향상** 시킨 제품으로써 특히 주방 요리 시 발생하는 각종 가스에 탁월한 선택성을 가지고 있으며 안정된 감지구조를 확보하여 반 영구적 사용이 가능하다.

- * LPG (Liquid Petroleum Gas) : 액화석유가스 → Butane(주성분, 부탄, C₄H₁₀), Propane (프로판, C₃H₈).
- * CNG or LNG (Compressible Natural Gas, Liquid Natural Gas) : 천연가스 → 주성분, Methane (메탄, CH₄)



< Package >

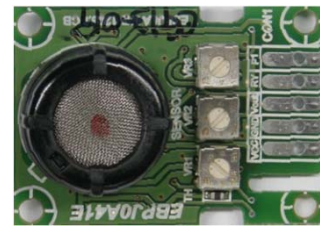

< Module (-P1XX) >

1. Sensitivity characteristic slope ($\beta = R_{s, gas} / R_{s, air}$)

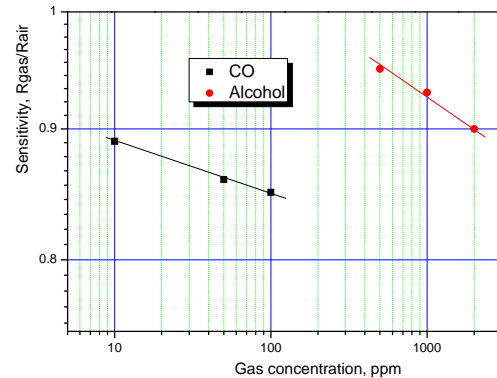
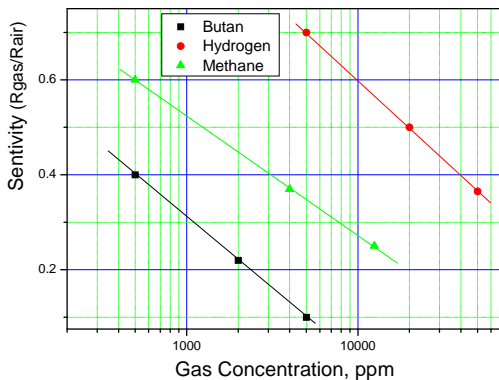

2. Basic Measuring Circuit

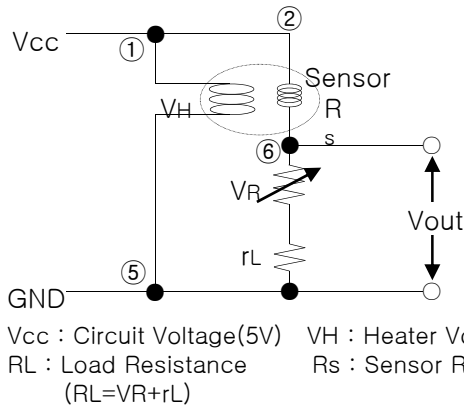

Long Term Stability

- Room condition & temperature

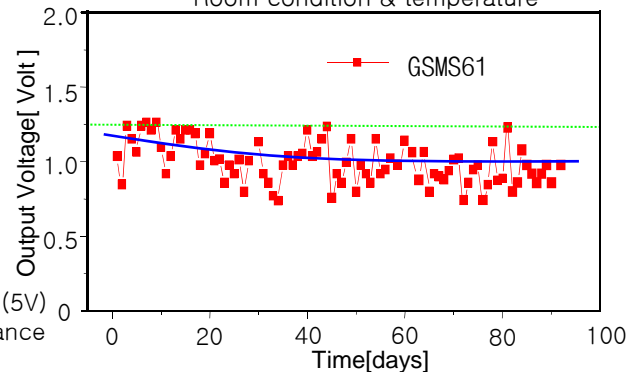

3. Specifications

3.1 Package (sensor) GSMS61 : Methane-CNG, GSPS61 : Butane-LPG



a. 정격

Model number		GSMS61(Package)	GSPS61(Package)
Sensing element type		Semiconductor	
Target gas		Butane, methane	
Electrical characteristics under standard Test conditions	R _H	Heater resistance	16Ω±0.3Ω
	V _H	Heater Voltage	5.0±0.1V
	R _L	Load resistance	Variable
	P _H	Power consumption	Less than 680mW
	V _C	Circuit Voltage	Less than 12.0V
Rs,air : Sensor resistance at Clean air		- Rs,air = 70kΩ to 811kΩ(청정대기)	
Sensitivity Characteristic	β (감도, sensitivity) β=Rs,gas/Rs,air	Methane 500ppm : 0.6±0.1 12,500ppm:0.25±0.05	i-Butane 500ppm : 0.4±0.1 4,500ppm : 0.15±0.05
	Vout = 1.0Volt±0.2Volt ΔV=(Vout,air) -(Vout,gas)	Methane 500ppm : 0.30~0.65V 12,500ppm : 1.25~1.75V	i-Butane 500ppm : 0.65~1.25V 4,500ppm : 1.75~2.55V
Change ratio of sensitivity	α = β2/β1	Methane : 0.28 ~ 0.60 β1 = Sensitivity at 500ppm β2 = Sensitivity at 4,500ppm	i-Butane : 0.20 ~ 0.67 β1 = Sensitivity at 500ppm β2 = Sensitivity at 12,500ppm
Response time	Reaction : less than 10sec		Recovery : less than 30sec
Environmental condition	* Standard test condition (balance gas : clean air, or special air) • Temp. : 20°C±5°C, • Humidity : RH65%±10%, • Pressure : 1atm • Test chamber : more than 1ℓ/EA, • Pre-heating time : more than 1hr		

b. 가스 농도별 출력 : 가스 농도오차 : ±15% (온도, 습도 보상 전)

- 기준 → RL : 100kΩ, Sensor resistance : 400kΩ, Vout,air : 1.0volt (센서 인가전압 5volt)
- 오차 : ±15% (온도, 습도 보상 전)

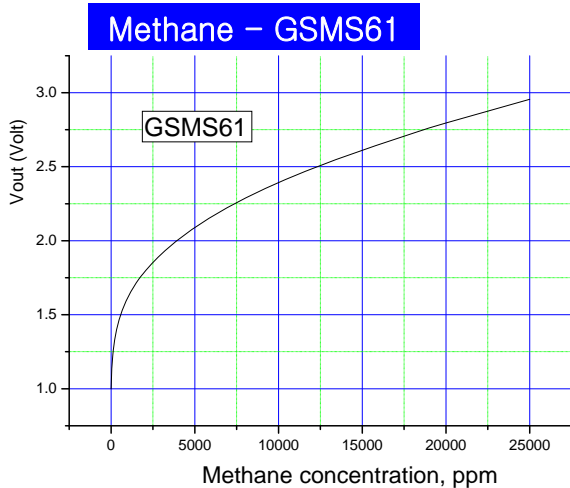

농도 (ppm)	출력 (Volt)	농도 (ppm)	출력 (Volt)	농도 (ppm)	출력 (Volt)	농도 (ppm)	출력 (Volt)
0	1.00	700	1.54	1,900	1.78	10,000	2.39
50	1.14	800	1.57	2,000	1.79	11,000	2.44
100	1.22	900	1.59	2,500	1.86	12,000	2.49
150	1.28	1,000	1.62	3,000	1.91	13,000	2.53
200	1.32	1,100	1.64	3,500	1.96	14,000	2.57
250	1.35	1,200	1.66	4,000	2.01	15,000	2.61
300	1.38	1,300	1.68	4,500	2.05	16,000	2.65
350	1.41	1,400	1.70	5,000	2.09	17,000	2.69
400	1.43	1,500	1.71	6,000	2.16	18,000	2.73
450	1.45	1,600	1.73	7,000	2.23	19,000	2.76
500	1.47	1,700	1.75	8,000	2.29	20,000	2.80
600	1.51	1,800	1.76	9,000	2.34	25,000	2.96

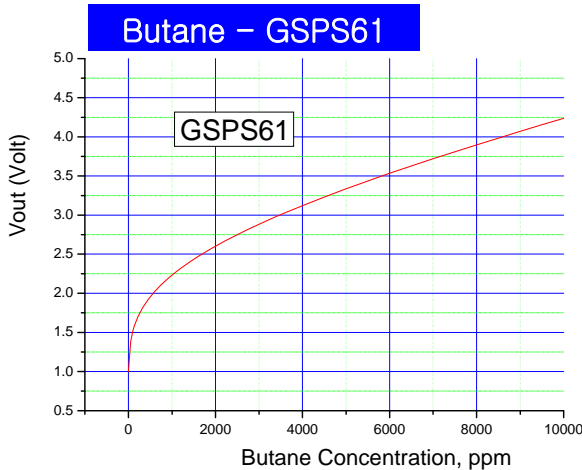

농도 (ppm)	출력 (Volt)	농도 (ppm)	출력 (Volt)	농도 (ppm)	출력 (Volt)	농도 (ppm)	출력 (Volt)
0	1.00	600	2.02	1,400	2.40	5,000	3.33
50	1.38	650	2.05	1,500	2.43	5,500	3.44
100	1.51	700	2.08	1,600	2.47	6,000	3.53
150	1.61	750	2.11	1,700	2.50	6,500	3.63
200	1.68	800	2.13	1,800	2.54	7,000	3.72
250	1.74	850	2.16	1,900	2.57	7,500	3.81
300	1.79	900	2.18	2,000	2.60	8,000	3.90
350	1.84	950	2.21	2,500	2.75	8,500	3.98
400	1.88	1,000	2.23	3,000	2.88	9,000	4.07
450	1.92	1,100	2.28	3,500	3.01	9,500	4.15
500	1.95	1,200	2.32	4,000	3.12	10,000	4.24
550	1.99	1,300	2.36	4,500	3.23		

기타 가스

$$\beta = R_{s,gas} / R_{s,air}$$

종 류	Sensitivity, β (1,000ppm)	특 성
Smoke	Less than 0.9	디스, Korea
Alcohol	Less than 0.8	Cooking gas
Butyl Acid	Less than 0.8	부페취, 발/땀냄새

c. Sensor connection

Sensor 저항(Rs) 및 RL 을('3.1-e' 참조) 확인한 후 Basic measuring circuit('2항')을 참조하여 결선 할 것.(주의 : 센서 저항은 재고에 따라 바뀔 수 있으며, 당사와 미리 협의 요망)

- Heater(DC 5volt \pm 3%) 극성 없음 → ① : Vcc ⑤ : GND,
- Sense(DC/AC 1 ~ 12volt) 극성 없음 → ② : Vcc ⑥ : RL

d. 출고

GSMS61-Q■■■

D ■■■ : 저항 분류 rank

ex) D20 -> Sensor 저항(Rs,air) : 163 ~ 206k Ω

RI를 45.3k Ω (표준 circuit 참조)을 부착할 경우 Vout=1.0volt \pm 0.25V출력

e. Sensor Resistance (Only package)

- Sensor Resistance Table(Only package) Rank Table No. : D(1 \pm 0.25Volt)

Rank No.	Q Rank Table (k Ω)			Rank No.	Q Rank Table (k Ω)		
	RL	Low limit	Hi limit		RL	Low limit	Hi limit
D14	10.7	38.5	48.7	D21	57.6	206	262
D15	13.7	48.7	62.4	D22	73.2	262	333
D16	17.4	62.4	79.3	D23	93.1	333	424
D17	22.1	79.3	101	D24	118	424	538
D18	28.0	101	128	D25	150	538	683
D19	35.7	128	163	D26	191	683	870
D20	45.3	163	206	D27	243	870	1,107

Rank Table(J) - Rank는 변경될 수 있습니다.

f. Structure and Dimensions

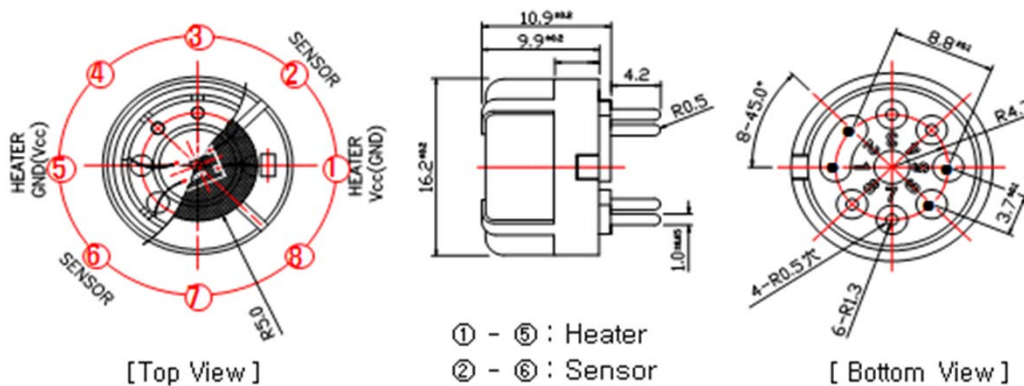



3.2 OP Module (Methane/Butane 겸용)

a. 정격

Index		Spec. & Test condition
Circuit Voltage	Vc	Module input Voltage : 5±0.1Volt
	PH	Power consumption : 710mW 이하, Inrush current : Less than 1500mA
Guarantee		- 3years over - Calibration interval 1years recommended
Worm up Time (T90)		- More then 300sec
Reaction time(T90)		- Reaction Time(T90) : Less then 5sec - Recovering Time(T90) : Less then 30sec

b. 가스 농도 별 data

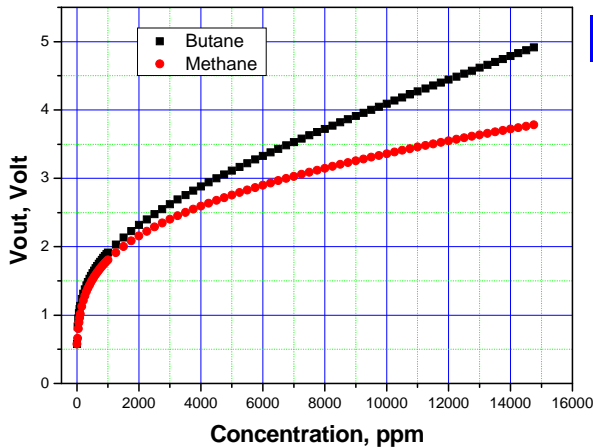

Butane, Methane

- Butane

$$(\text{ppm}) = 878.829 - 1901.171(\text{Vout}) + 1033.507(\text{Vout})^2$$

- Methane

$$(\text{ppm}) = 10^{(0.361 + 1.848 * (\text{Volt}) - 0.226 * (\text{Volt})^2)}$$

Methane GSMS61-P110

농도 (ppm)	출력 (Volt)	농도 (ppm)	출력 (Volt)	농도 (ppm)	출력 (Volt)	농도 (ppm)	출력 (Volt)
0	0.58	700	1.66	1,900	2.13	10,000	3.36
50	0.85	800	1.71	2,000	2.16	11,000	3.46
100	1.02	900	1.76	2,500	2.29	12,000	3.55
150	1.13	1,000	1.81	3,000	2.40	13,000	3.64
200	1.21	1,100	1.85	3,500	2.50	14,000	3.72
250	1.28	1,200	1.90	4,000	2.59	15,000	3.80
300	1.34	1,300	1.93	4,500	2.68	16,000	3.88
350	1.39	1,400	1.97	5,000	2.76	17,000	3.96
400	1.44	1,500	2.01	6,000	2.90	18,000	4.03
450	1.48	1,600	2.04	7,000	3.03	19,000	4.10
500	1.52	1,700	2.07	8,000	3.15	20,000	4.17
600	1.59	1,800	2.10	9,000	3.26	25,000	4.49

Butane GSPS61-P110

농도 (ppm)	출력 (Volt)	농도 (ppm)	출력 (Volt)	농도 (ppm)	출력 (Volt)	농도 (ppm)	출력 (Volt)
0	0.58	450	1.57	1,250	2.03	4,250	2.94
20	0.84	500	1.61	1,500	2.14	4,500	3.00
40	0.95	550	1.65	1,750	2.23	4,750	3.06
60	1.03	600	1.69	2,000	2.32	5,000	3.11
80	1.09	650	1.72	2,250	2.40	5,250	3.17
100	1.14	700	1.75	2,500	2.48	5,500	3.22
150	1.24	750	1.78	2,750	2.55	5,750	3.28
200	1.31	800	1.81	3,000	2.62	6,000	3.33
250	1.38	850	1.84	3,250	2.69	6,250	3.38
300	1.44	900	1.86	3,500	2.76	6,500	3.43
350	1.49	950	1.89	3,750	2.82	6,750	3.48
400	1.53	1,000	1.92	4,000	2.88	7,000	3.53

100129_NPG Module출력-kc



Best solution of Measuring & Control system
Long term stability & High reliability
in sensing worldwide

#202, POST-BI, 970-14, Wolchul-dong, Buk-gu,
Gwangju, 500-460, KOREA

Home Page : www.ogamtech.com Tel:(062)973-9342
E-mail : with@ogamtech.com Fax:(062)973-9344

c. Structure and Dimensions

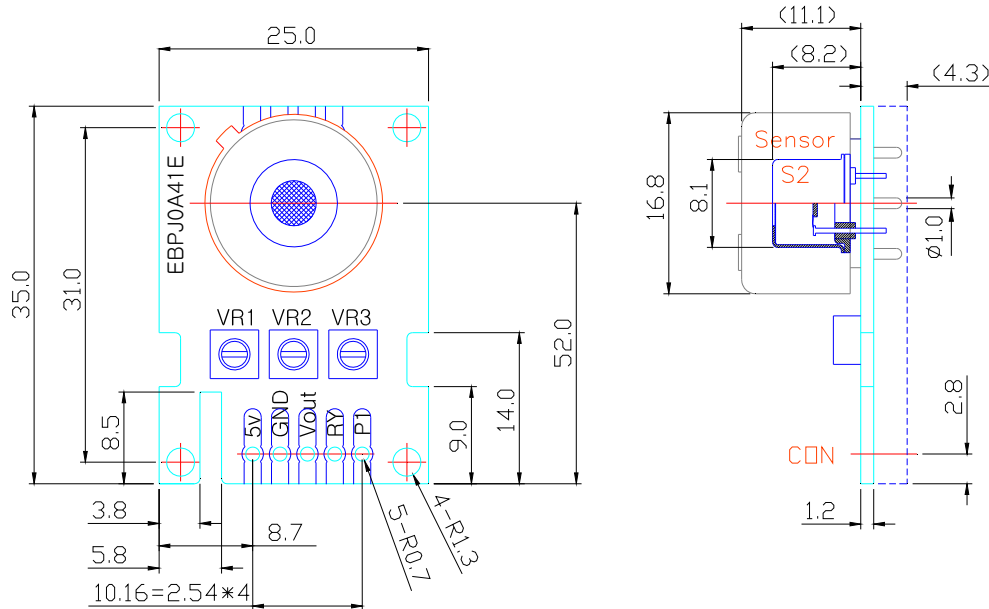

VR1 : 초기 reference 값 조정, VR2 : Gain (감도 조정), VR3 : Offset (Level shift)

* 현장 응용 출력 조정 방법

- ① VR3을 이용하여 출력조정
 - 가변저항의 위치에 따라 조정 범위가 다를 수 있음(max. ± 0.5 volt)
- ② VR1을 이용하여 출력 조정 (VR3를 이용한 조정이 불가할 경우)
 - VR1(+cc) : 전체적으로 출력이 증가 됨
 - VR1(-cc) : 전체적으로 출력이 감소 됨

d. Data output



- ① Vcc : 5.0volt
- ② GND
- ③ Data(Vout, analogue signal)
- ④ Relay

e. Relay Output

- Normal condition : Less than 0.3volt
- Hi output(4.0~4.1volt) at more than 10ppm(toluene)

3.3 RL Module(GSMS61/GSPS61-P3xx), MOQ : 500pcs 이상



a. Characteristics

Index		Spec. & Test condition
Circuit Voltage	Vc	Module input Voltage : 5 ± 0.1 Volt
	PH	Power consumption : 680mW 이하, Inrush current : Less than 1600mA
Guarantee		- 3years over - Calibration interval 1years recommended
Operating environment		- Temp. : $-10 \sim 50^{\circ}\text{C}$, Humidity : $5 \sim 90\% \text{RH}$, Non-condensing - Storage \rightarrow Temp. : $-20 \sim 70^{\circ}\text{C}$, Humidity : $0 \sim 90\% \text{RH}$
Reaction time(T90)		- Reaction Time(T90) : Less then 10sec - Recovering Time(T90) : Less then 180sec

b. 가스 농도 별 전압 출력

- Out Data : '3-1.b' 참조
- 오차 : $\pm 10\%$ (온도, 습도 보상 전)

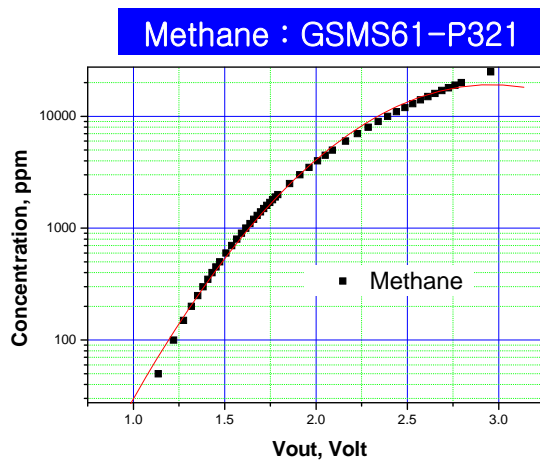

계산식

$$(\text{ppm}) = 10^{(-2.122 + 4.330 * (\text{Vout}) - 0.732 * (\text{Vout})^2)}$$

계산식

$$(\text{ppm}) = 10^{(-1.455 + 2.874 * (\text{Vout}) - 0.396 * (\text{Vout})^2)}$$

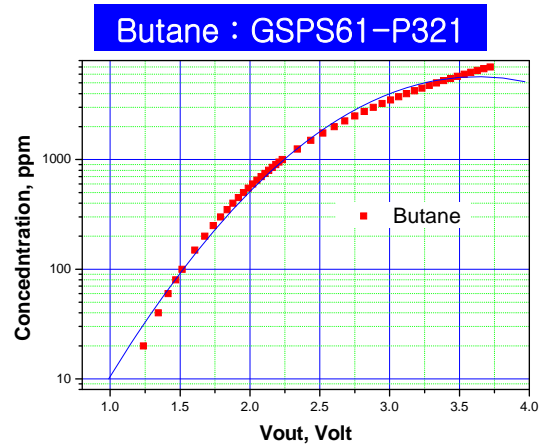

d. Structure and Dimensions

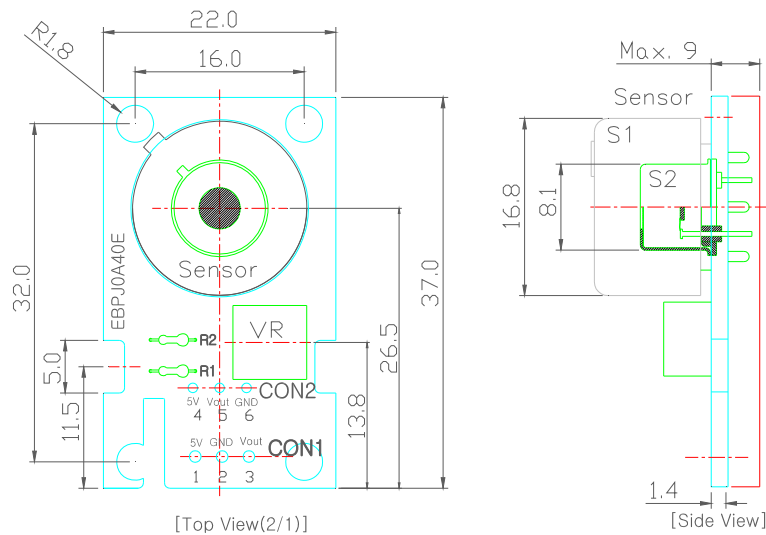

e. Data output (CON1, CON2 배선에 주의할 것)

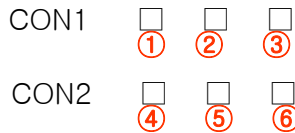

- ①, ④ → Vcc : 5.0volt
- ②, ⑥ → GND
- ③, ⑤ → Data(Vout, analogue signal)

3.4 Product code & characteristics

Product code	Consumption	Circuit	Output	Worm-up time
GSMS61 GSPS61	650mW 이하	None	Data : Analogue	Long
GSXS61 - P1XX	680mW 이하	OP-Amplifying	Data : Analogue Relay : Hi(4V), Low(0V)	Long
Study- P2XX	↑	μ-processor	Data : Digital Open collect	short
GSXS61 - P3XX	650mW 이하	Basic Circuit	Data : Analogue	Long

4. 제품 비교

Index	GSM(P)S61	GSM(P)S61-P11X	GSM(P)S61-P21X ^{study}	GSM(P)S61-P3XX
Circuit	Package	OP-Module	MP-Module	RL-Module
Target Gas	CNG(Methane), LPG(i-Butane)			
Accuracy	±15%	±7%	±7%	±10%
Measuring Circuit	Basic Circuit	Op-Amp	Micro Processor	Basic Circuit
Input Voltage	5Volt±3%	←	←	←
Output	0 ~ 4volt	0 ~ 4volt	Open collect	0 ~ 4volt
MOQ	None	None	None	More than 500ea

5. Reaction time(T90)

Reaction Time(T90) : Less then 10sec

[Between Rs,air_b & Rs,gas]

Recovering Time(T90) : Less then 30sec

[between Rs,gas & Rs,air_a]

Beginning stability time(T90) : Less then 10 min

Rs,air_b : Sensor Resistance without gases

Rs,gas : Sensor Resistance after blowing gases

Rs,air_a : Sensor Resistance removing gases

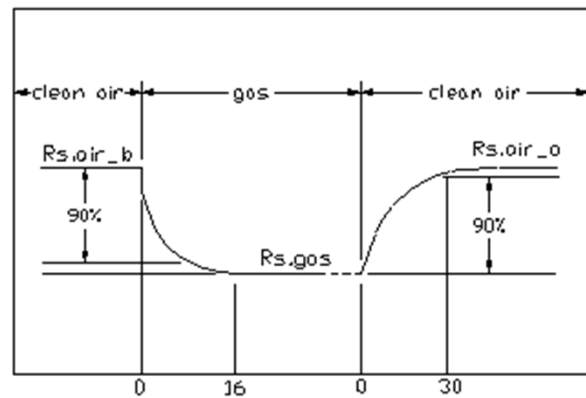

6. Application

6.1 Hood, Ventilator, Damper, Gas Leak Alarm (Explosive gases)

6.2 납땜 시 프릭스가 센서에 닿지 않도록 주의할 것.

6.3 Epoxy PCB(FR4)를 사용 할 경우, PCB면으로부터 2~3mm 정도 띄워줄 것.

7. Product code

GSMS61 - P ■ ■ ■

(1) (2) (3) (4)

(1) GSMS61 → CNG Sensor GSPS61 → LPG Sensor

(2) Division Circuit → 1:Op-amp circuit 2:Micro processor Circuit 3:Basic Circuit

(3) Gas sensing range → 1:Standard

(4) Connector → 0:None 1:in

* 본 규격서는 summary 규격서로 제품 향상을 위하여 공지 없이 변경될 수 있음을 알려드립니다.