

HYDs Sensor,

– for the detection of Hydrogen

GSHS61

CNG/LPG/Hydrogen 가



<GSHS61>



<GSHS61 - P1xx>

가 : 가
 * : ¼ 가 . (:4 ~ 75%)
 가 .

* LPG (Liquid Petroleum Gas) 가 → Butane(, C₄H₁₀), Propane (, C₃H₈).

* CNG or LNG (Natural Gas, Liquid Natural Gas) 가 → , Methane (, CH₄), Hydrogen (, H₂)

1. Sensitivity characteristic slope

< Module(GSHS61 - P110) >

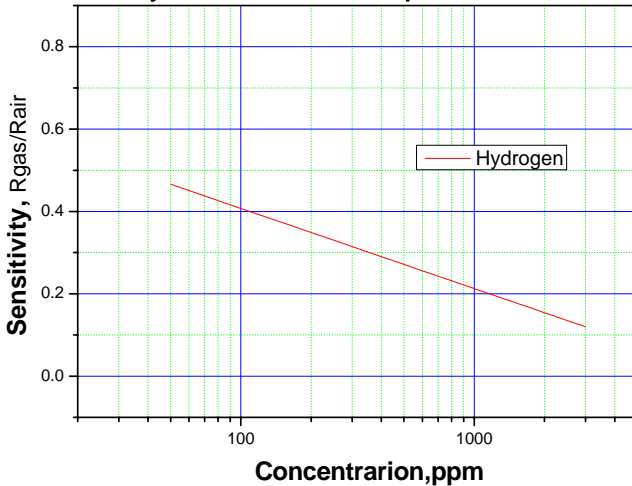

(ppm)	(ppm)	(ppm)	(ppm)
0	1	600	0.256
50	0.466	650	0.249
100	0.408	700	0.243
150	0.373	750	0.237
200	0.349	800	0.232
250	0.330	850	0.227
300	0.315	900	0.222
350	0.302	950	0.217
400	0.290	1000	0.213
450	0.280	1050	0.209
500	0.271	1100	0.205
550	0.263	1150	0.201
		1200	0.197
		1250	0.194
		1300	0.191
		1350	0.187
		1400	0.184
		1450	0.181
		1500	0.178
		1550	0.176
		1600	0.173
		1650	0.170
		1700	0.168
		1750	0.165
		1800	0.163
		1850	0.161
		1900	0.158
		1950	0.156
		2000	0.154
		2050	0.152
		2100	0.150
		2150	0.148
		2200	0.146
		2250	0.144
		2300	0.142
		2350	0.141

$$(Sensitivity) = 0.797 - 0.195 \times \log_{10}(ppm)$$

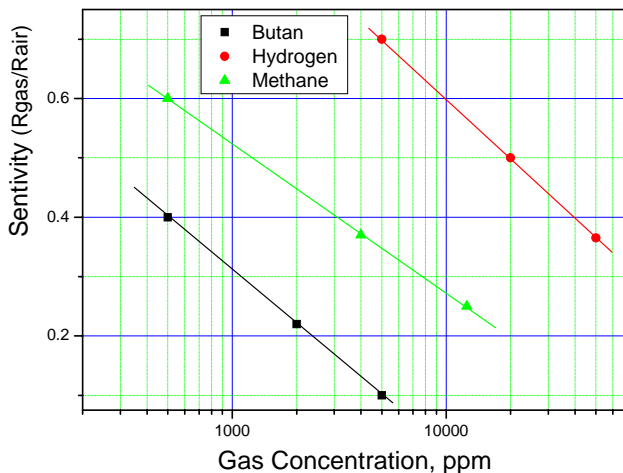

2. Basic Measuring Circuit

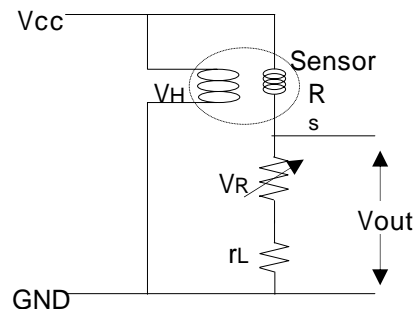

Vcc : Circuit Voltage(5V) VH : Heater Voltage(5V)
 RL : Load Resistance Rs : Sensor Resistance
 (RL=VR+rL)

3. Specifications

3.1 Package (GSHS61), MOQ :



a. Characteristics

Index		Spec. & Test condition				
Circuit Voltage	Vc	Sensor input Voltage : 1 ~ 12V, Sensor Resistance : refer to Rank table				
	VH	Heater input voltage : 5volt ± 1%, Heater Resistance : 16.0 ± 1.0				
	PH	Power consumption : 680mW , Inrush current : Less than 300mA				
Characteristics of sensitivity () (Rs,gas / Rs,air)	Gases	Methane	Alcohol	Smoke	Butyl Acid	
	Concentration	100ppm	1,000ppm	1,000ppm	1,000ppm	
	Sensitivity	0.5	0.7	0.8	0.7	
Guarantee	- 3years - Calibration interval 1years recommended					
Operating environment	- Temp. : -10 ~ 50 , Humidity : 5 ~ 90%RH, Non-condensing - Storage → Temp. : -10 ~ 70 , Humidity : 0 ~ 90%RH					
Reaction time(T90)	- Reaction Time(T90) : Less then 10sec - Recovering Time(T90) : Less then 30sec					

b. 가 : : ±15% (,)

→ RL : 100kΩ, Sensor resistance : 10kΩ, Vout,air : 1.0volt (Input Voltage 5volt)

Con. (ppm)	Sensi-tivity	Con. (ppm)	Sensi-tivity	Con. (ppm)	Sensi-tivity	Con. (ppm)	Sensi-tivity
0	1.000	240	0.333	480	0.275	720	0.241
20	0.544	260	0.327	500	0.271	740	0.238
40	0.485	280	0.320	520	0.268	760	0.236
60	0.451	300	0.315	540	0.265	780	0.234
80	0.426	320	0.309	560	0.262	800	0.232
100	0.408	340	0.304	580	0.259	820	0.230
120	0.392	360	0.299	600	0.256	840	0.228
140	0.379	380	0.295	620	0.253	860	0.226
160	0.368	400	0.290	640	0.251	880	0.224
180	0.358	420	0.286	660	0.248	900	0.222
200	0.349	440	0.282	680	0.245	920	0.220
220	0.341	460	0.278	700	0.243	940	0.218

$$(Sensitivity) = 0.797 - 0.195 * \log_{10}(ppm)$$

* Sensitivity() = Rgas/Rair

* Rgas : 가 , Rair :

C. Output Voltage

- → RL : 100kΩ, Sensor resistance : 400kΩ, Vout,air : 0.9volt (가 5volt)

- : ±15% (,)

$$(ppm) = 10^{(-1.4703+2.2276(volt)-0.2463(volt)^2)}$$

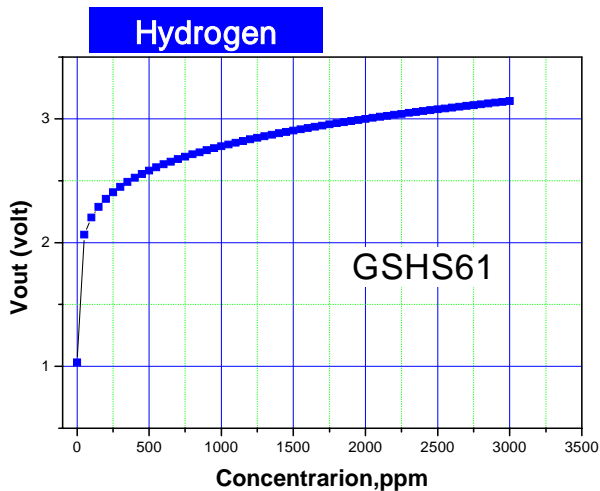

(ppm)	(Volt)	(ppm)	(Volt)	(ppm)	(Volt)	(ppm)	(Volt)
0	1.000	750	2.566	1500	2.917	2250	3.171
50	1.745	800	2.595	1550	2.936	2300	3.186
100	1.901	850	2.623	1600	2.955	2350	3.201
150	2.006	900	2.650	1650	2.973	2400	3.216
200	2.087	950	2.676	1700	2.991	2450	3.230
250	2.155	1000	2.701	1750	3.009	2500	3.244
300	2.214	1050	2.725	1800	3.026	2550	3.259
350	2.266	1100	2.749	1850	3.043	2600	3.273
400	2.314	1150	2.772	1900	3.060	2650	3.286
450	2.357	1200	2.794	1950	3.077	2700	3.300
500	2.397	1250	2.816	2000	3.093	2750	3.314
550	2.435	1300	2.837	2050	3.109	2800	3.327
600	2.470	1350	2.858	2100	3.125	2850	3.341
650	2.504	1400	2.878	2150	3.140	2900	3.354
700	2.536	1450	2.898	2200	3.156	2950	3.367

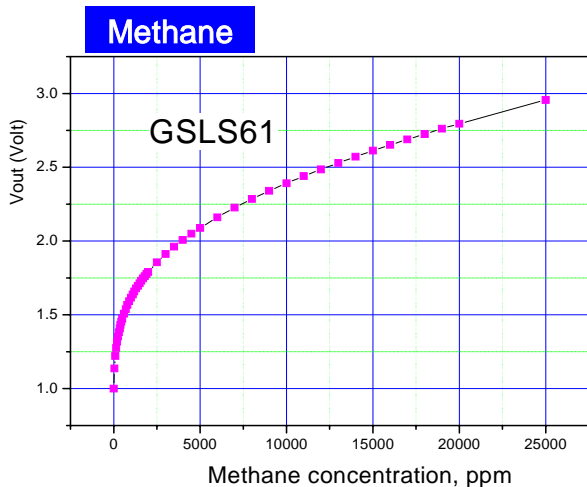

(ppm)	(Volt)	(ppm)	(Volt)	(ppm)	(Volt)	(ppm)	(Volt)
0	1.00	700	1.54	1,900	1.78	10,000	2.39
50	1.14	800	1.57	2,000	1.79	11,000	2.44
100	1.22	900	1.59	2,500	1.86	12,000	2.49
150	1.28	1,000	1.62	3,000	1.91	13,000	2.53
200	1.32	1,100	1.64	3,500	1.96	14,000	2.57
250	1.35	1,200	1.66	4,000	2.01	15,000	2.61
300	1.38	1,300	1.68	4,500	2.05	16,000	2.65
350	1.41	1,400	1.70	5,000	2.09	17,000	2.69
400	1.43	1,500	1.71	6,000	2.16	18,000	2.73
450	1.45	1,600	1.73	7,000	2.23	19,000	2.76
500	1.47	1,700	1.75	8,000	2.29	20,000	2.80
600	1.51	1,800	1.76	9,000	2.34	25,000	2.96

가

$$= R_{s,gas} / R_{s,air}$$

	Sensitivity, (1,000ppm)	
Smoke	Less than 0.9	, Korea
Alcohol	Less than 0.8	Cooking gas
Butyl Acid	Less than 0.8	, /

d. Sensor connection

- Sensor (Rs) RL Basic measuring circuit('2 ')
 .(: ,)

e. Product code

GSAT11-J

J : rank ex) J04 -> Sensor (Rs,air) : 36.6 ~ 60.4kΩ

Sensor resistance Table (Only package)

Rank Table No.:

Rank	RL	Rs,	Rank	RL	Rs,	Rank	RL	Rs,
J02	4.22kΩ	13.4 ~ 22.2kΩ	J05	19.1kΩ	60.4 ~ 100kΩ	J08	86.6kΩ	275 ~ 455kΩ
J03	6.98kΩ	22.2 ~ 36.6kΩ	J06	31.6kΩ	100 ~ 166kΩ	J09	143kΩ	455 ~ 751kΩ
J04	11.5kΩ	36.6 ~ 60.4kΩ	J07	52.3kΩ	166 ~ 275kΩ	J10	237kΩ	751 ~ 1,244kΩ

* Rank

f. Structure and Dimensions

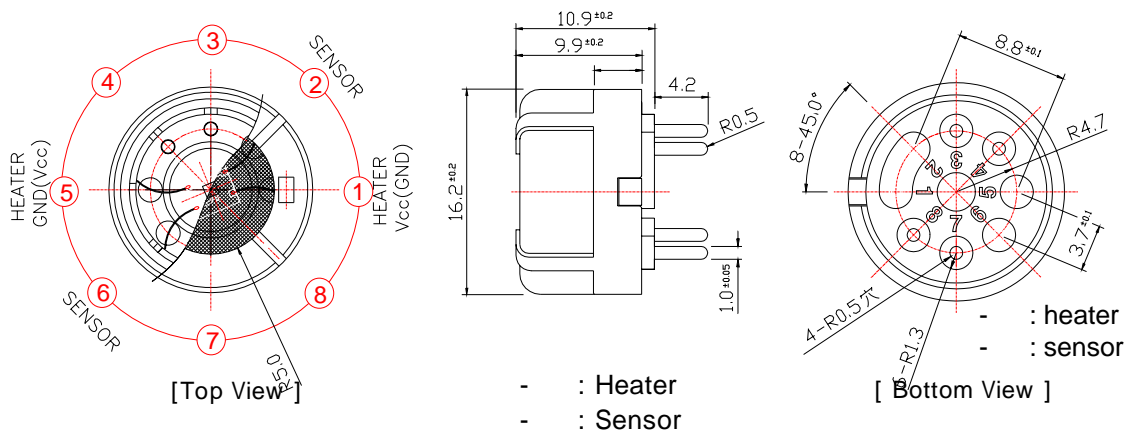

g.

- (Flux)
 - Gas 20mm 가

3.2 Module (GSHS61 - P1xx)



a.

- Input voltage : 5Volt \pm 3%
- Power consumption : 710mW
- (: 가
- Output data : 0.5 ~ 5Volt
- Relay Output : 4.0Volt

b. Sensor connection

- calibration VR
- .(Vcc GND가 short)

c. 가 data sheet : \pm 7% (,)

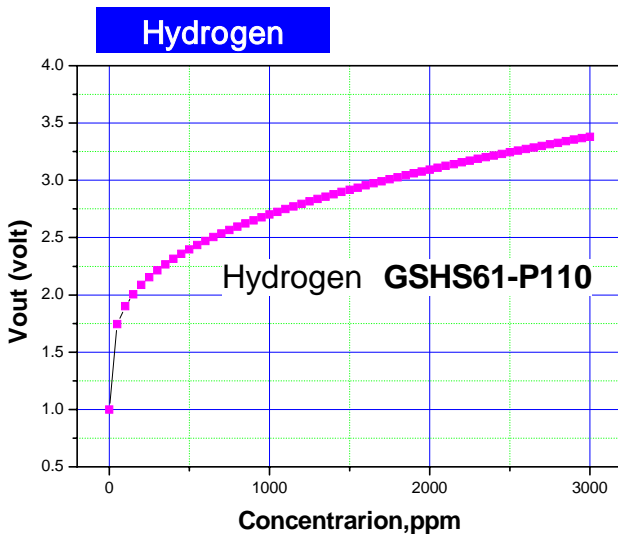

(ppm)	(Volt)	(ppm)	(Volt)	(ppm)	(Volt)	(ppm)	(Volt)
0	0.878	750	2.841	1,500	3.281	2,250	3.60
50	1.812	800	2.878	1,550	3.305	2,300	3.62
100	2.007	850	2.913	1,600	3.329	2,350	3.64
150	2.138	900	2.946	1,650	3.351	2,400	3.66
200	2.241	950	2.979	1,700	3.374	2,450	3.67
250	2.326	1,000	3.010	1,750	3.396	2,500	3.69
300	2.400	1,050	3.041	1,800	3.418	2,550	3.71
350	2.465	1,100	3.070	1,850	3.439	2,600	3.73
400	2.525	1,150	3.099	1,900	3.460	2,650	3.74
450	2.579	1,200	3.127	1,950	3.481	2,700	3.76
500	2.630	1,250	3.154	2,000	3.501	2,750	3.78
550	2.677	1,300	3.181	2,050	3.522	2,800	3.80
600	2.721	1,350	3.207	2,100	3.541	2,850	3.81
650	2.763	1,400	3.232	2,150	3.561	2,900	3.83
700	2.803	1,450	3.257	2,200	3.580	2,950	3.84

d. Characteristics and Dimensions

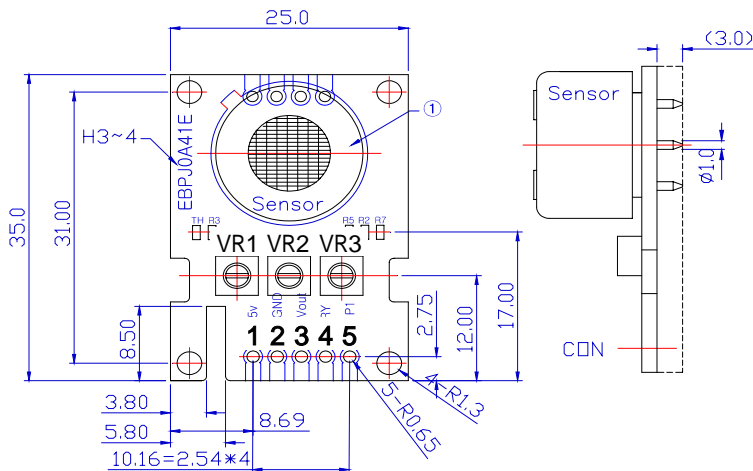

- Output Data

1	2	3	4
+5V	GND	Vout	Relay

- Relay Output

Vout 3volt(2,000ppm)
Hi(4volt)

